

Silicon Tuning Diodes

- Excellent linearity
- High Q hyperabrupt tuning diode
- Low series resistance
- Designed for low tuning voltage operation for VCO's in mobile communications equipment
- For low frequency control elements such as TCXOs and VCXOs
- Very low capacitance spread
- Pb-free (RoHS compliant) package¹⁾
- Qualified according AEC Q101



BBY58-02L/V
BBY58-02W
BBY58-03W

BBY58-05W

BBY58-06W

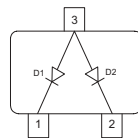
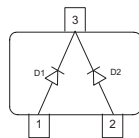
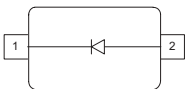

Type	Package	Configuration	L_S (nH)	Marking
BBY58-02L	TSLP-2-1	single, leadless	0.4	88
BBY58-02V	SC79	single	0.6	8
BBY58-02W	SCD80	single	0.6	88
BBY58-03W	SOD323	single	0.6	8 yel.
BBY58-05W	SOT323	common cathode	1.4	B5s
BBY58-06W	SOT323	common anode	1.4	B6s

Maximum Ratings at $T_A = 25^\circ\text{C}$, unless otherwise specified

Parameter	Symbol	Value	Unit
Diode reverse voltage	V_R	10	V
Forward current	I_F	20	mA
Operating temperature range	T_{op}	-55 ... 150	°C
Storage temperature	T_{stg}	-55 ... 150	

¹⁾Pb-containing package may be available upon special request

Electrical Characteristics at $T_A = 25^\circ\text{C}$, unless otherwise specified

Parameter	Symbol	Values			Unit
		min.	typ.	max.	
DC Characteristics					
Reverse current	I_R				nA
$V_R = 8\text{ V}$		-	-	10	
$V_R = 8\text{ V}, T_A = 85^\circ\text{C}$		-	-	100	
AC Characteristics					
Diode capacitance	C_T				pF
$V_R = 1\text{ V}, f = 1\text{ MHz}$		17.5	18.3	19.3	
$V_R = 2\text{ V}, f = 1\text{ MHz}$		11.4	12.35	13.3	
$V_R = 3\text{ V}, f = 1\text{ MHz}$		7.8	8.6	9.3	
$V_R = 4\text{ V}, f = 1\text{ MHz}$		5.5	6	6.6	
$V_R = 6\text{ V}, f = 1\text{ MHz}$		3.8	4.7	5.5	
Capacitance ratio	C_{T1}/C_{T3}	1.9	2.15	2.4	-
$V_R = 1\text{ V}, V_R = 3\text{ V}, f = 1\text{ MHz}$					
Capacitance ratio	C_{T1}/C_{T4}	2.7	3.05	3.5	
$V_R = 1\text{ V}, V_R = 4\text{ V}, f = 1\text{ MHz}$					
Capacitance ratio	C_{T4}/C_{T6}	1.15	1.3	1.45	
$V_R = 4\text{ V}, V_R = 6\text{ V}, f = 1\text{ MHz}$					
Series resistance	r_S				Ω
$V_R = 1\text{ V}, f = 470\text{ MHz}, \text{BBY58-02L}, -07\text{L4}$		-	0.3	-	
$V_R = 1\text{ V}, f = 470\text{ MHz}, \text{all other}$		-	0.25	-	

Diode capacitance $C_T = f(V_R)$

$f = 1\text{MHz}$

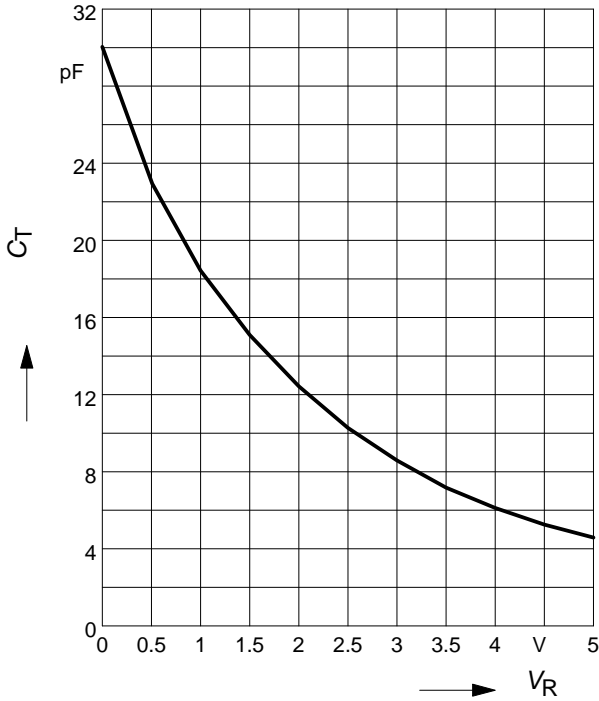

Normalized diode capacitance

$C_{(T_A)}/C_{(25^\circ\text{C})} = f(T_A)$

$f = 1\text{MHz}, V_R = \text{Parameter}$

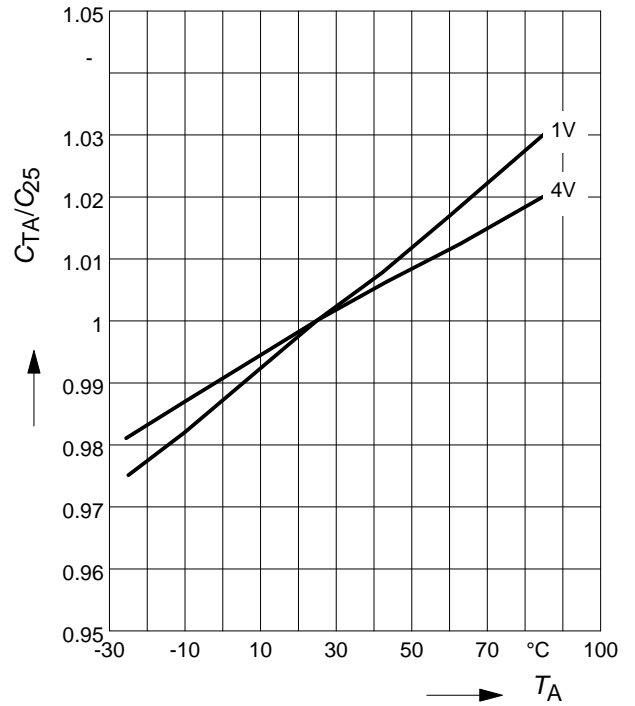

Temperature coefficient of the diode capacitance $T_{CC} = f(V_R)$

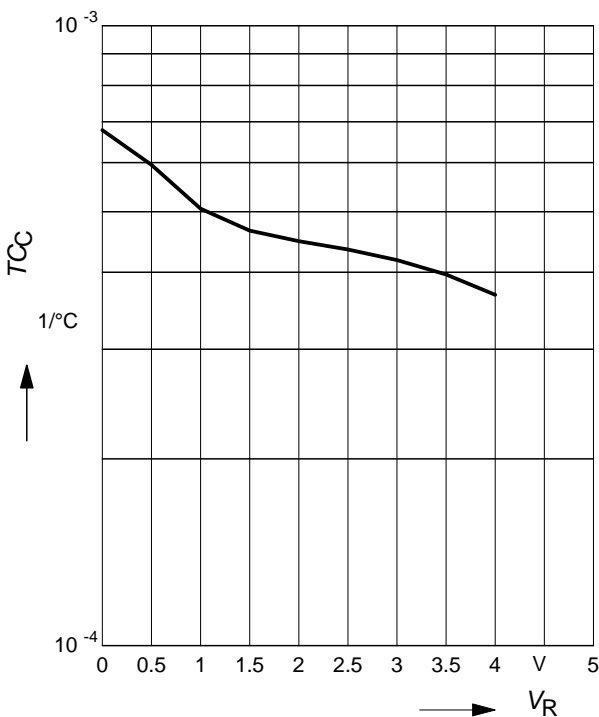

Package Outline

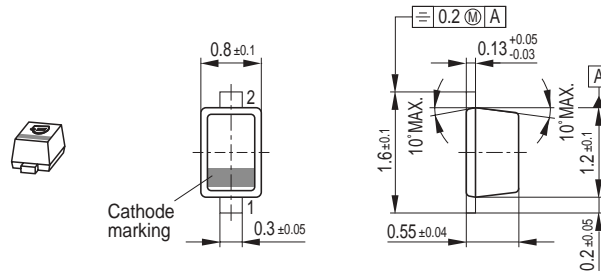

Foot Print

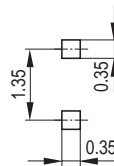

Marking Layout (Example)

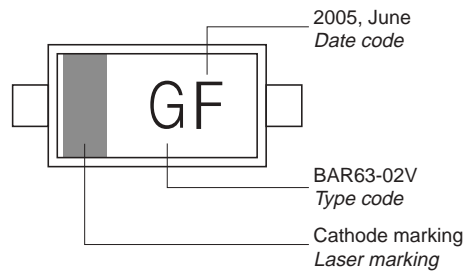

Standard Packing

Reel ø180 mm = 3.000 Pieces/Reel
 Reel ø180 mm = 8.000 Pieces/Reel (2 mm Pitch)
 Reel ø330 mm = 10.000 Pieces/Reel

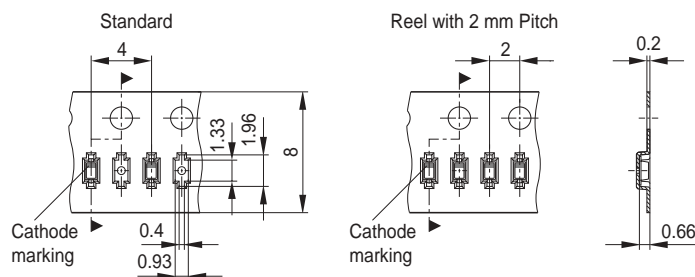

Package Outline

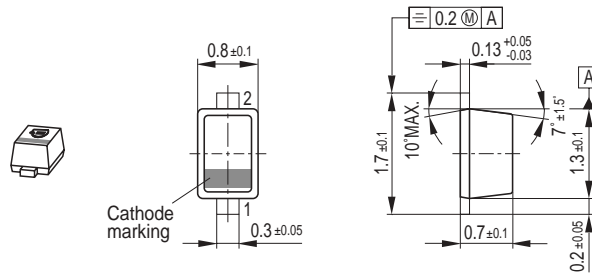

Foot Print

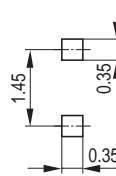

Marking Layout (Example)

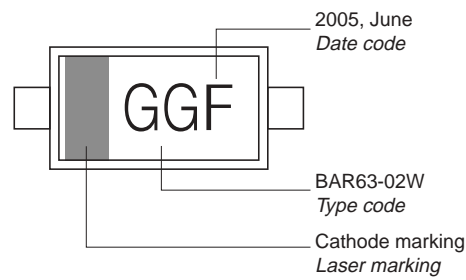

Standard Packing

Reel ø180 mm = 3.000 Pieces/Reel
 Reel ø180 mm = 8.000 Pieces/Reel (2 mm Pitch)
 Reel ø330 mm = 10.000 Pieces/Reel

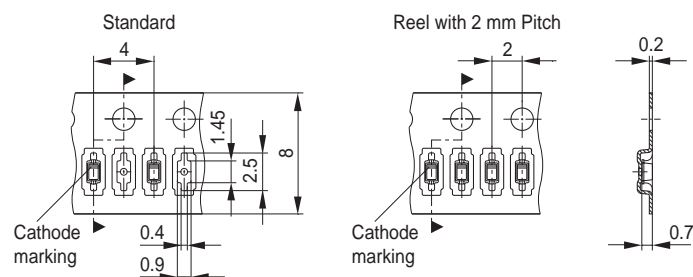

Date Code marking for discrete packages with one digit (SCD80, SC79, SC75¹⁾) CES-Code

Month	2003	2004	2005	2006	2007	2008	2009	2010	2011	2012	2013	2014
01	a	p	A	P	a	p	A	P	a	p	A	P
02	b	q	B	Q	b	q	B	Q	b	q	B	Q
03	c	r	C	R	c	r	C	R	c	r	C	R
04	d	s	D	S	d	s	D	S	d	s	D	S
05	e	t	E	T	e	t	E	T	e	t	E	T
06	f	u	F	U	f	u	F	U	f	u	F	U
07	g	v	G	V	g	v	G	V	g	v	G	V
08	h	x	H	X	h	x	H	X	h	x	H	X
09	j	y	J	Y	j	y	J	Y	j	y	J	Y
10	k	z	K	Z	k	z	K	Z	k	z	K	Z
11	l	2	L	4	l	2	L	4	l	2	L	4
12	n	3	N	5	n	3	N	5	n	3	N	5

1) New Marking Layout for SC75, implemented at October 2005.

Package Outline

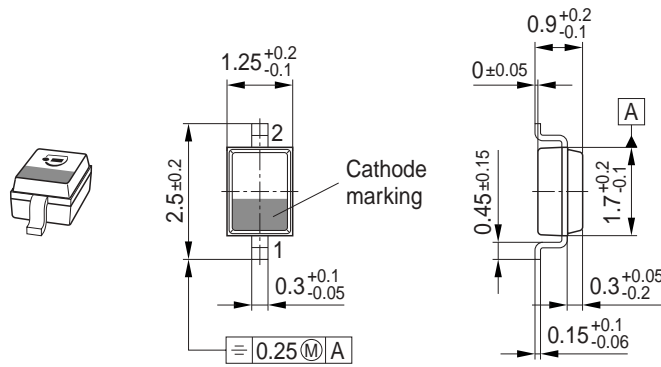

Foot Print

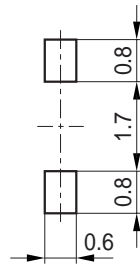

Marking Layout (Example)

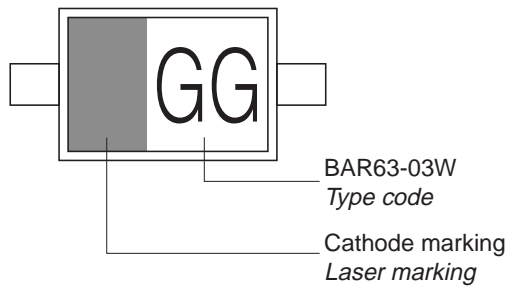

Standard Packing

Reel \varnothing 180 mm = 3.000 Pieces/Reel
 Reel \varnothing 330 mm = 10.000 Pieces/Reel

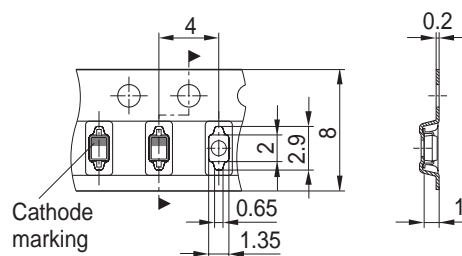

Package Outline

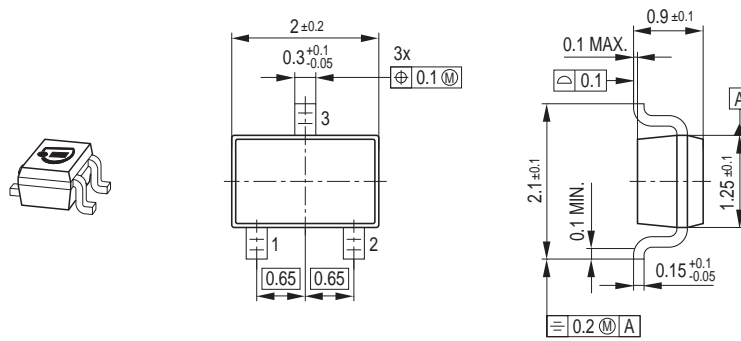

Foot Print

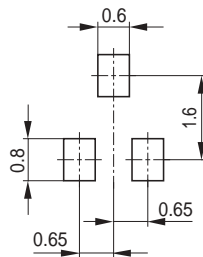

Marking Layout (Example)

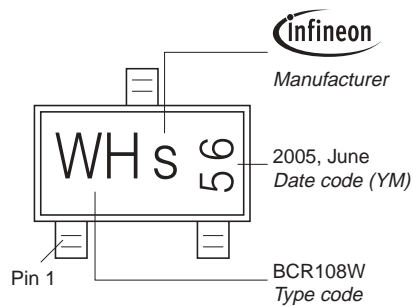

Standard Packing

Reel \varnothing 180 mm = 3.000 Pieces/Reel
 Reel \varnothing 330 mm = 10.000 Pieces/Reel

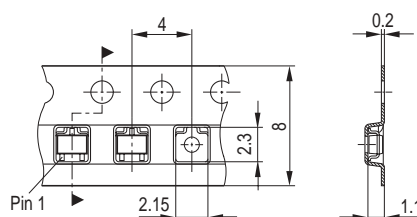

Package Outline

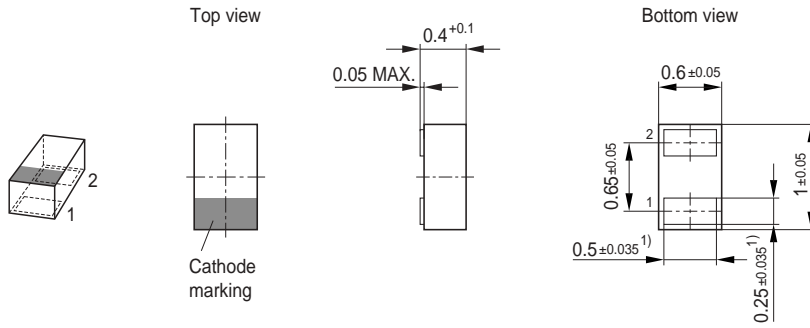

1) Dimension applies to plated terminal

Foot Print

For board assembly information please refer to Infineon website "Packages"

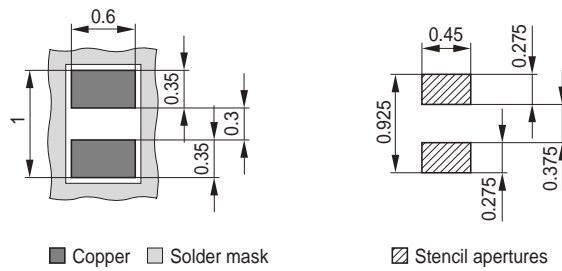

■ Copper □ Solder mask

▨ Stencil apertures

Marking Layout (Example)

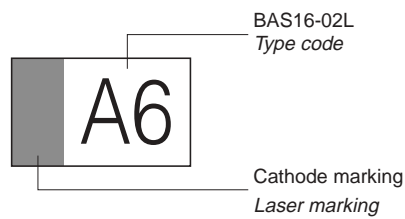

BAS16-02L
Type code

Cathode marking
Laser marking

Standard Packing

Reel \varnothing 180 mm = 15.000 Pieces/Reel
Reel \varnothing 330 mm = 50.000 Pieces/Reel (optional)

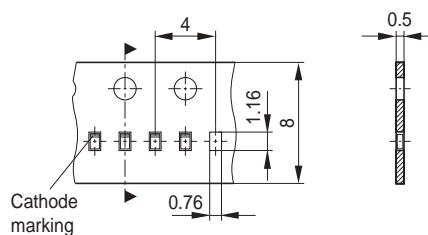

Edition 2006-02-01
Published by
Infineon Technologies AG
81726 München, Germany
© Infineon Technologies AG 2007.
All Rights Reserved.

Attention please!

The information given in this dokument shall in no event be regarded as a guarantee of conditions or characteristics ("Beschaffenhheitsgarantie"). With respect to any examples or hints given herein, any typical values stated herein and/or any information regarding the application of the device, Infineon Technologies hereby disclaims any and all warranties and liabilities of any kind, including without limitation warranties of non-infringement of intellectual property rights of any third party.

Information

For further information on technology, delivery terms and conditions and prices please contact your nearest Infineon Technologies Office (www.infineon.com).

Warnings

Due to technical requirements components may contain dangerous substances. For information on the types in question please contact your nearest Infineon Technologies Office.

Infineon Technologies Components may only be used in life-support devices or systems with the express written approval of Infineon Technologies, if a failure of such components can reasonably be expected to cause the failure of that life-support device or system, or to affect the safety or effectiveness of that device or system.

Life support devices or systems are intended to be implanted in the human body, or to support and/or maintain and sustain and/or protect human life. If they fail, it is reasonable to assume that the health of the user or other persons may be endangered.